

UV flame detector UVC 1

OPERATING INSTRUCTIONS

Cert. Version 12.20 · Edition 01.24 · EN · 03251460



1 SAFETY

1.1 Please read and keep in a safe place



Please read through these instructions carefully before installing or operating. Following the installation, pass the instructions on to the operator. This unit must be installed and commissioned in accordance with the regulations and standards in force. These instructions can also be found at www.docuthek.com.

1.2 Explanation of symbols

1, 2, 3, a, b, c = Action

→ = Instruction

1.3 Liability

We will not be held liable for damage resulting from non-observance of the instructions and non-compliant use.

1.4 Safety instructions

Information that is relevant for safety is indicated in the instructions as follows:

⚠ DANGER

Indicates potentially fatal situations.

⚠ WARNING

Indicates possible danger to life and limb.

⚠ CAUTION

Indicates possible material damage.

All interventions may only be carried out by qualified gas technicians. Electrical interventions may only be carried out by qualified electricians.

1.5 Conversion, spare parts

All technical changes are prohibited. Only use OEM spare parts.

CONTENTS

1 Safety	1
2 Checking the usage	2
3 Installation	2
4 Wiring	3
5 Adjustment	4
6 Commissioning	5
7 Maintenance	5
8 Assistance in the event of malfunction	6
9 Reading or setting flame signal, parameters, statistics	8
10 Technical data	9
11 Designed lifetime	9
12 Safety instructions	9
13 Accessories	10
14 Logistics	10
15 Certification	11
16 Disposal	12

2 CHECKING THE USAGE

In industrial thermoprocessing systems, the UV flame detector UVC 1 is designed to monitor flames which emit UV radiation. The UV flame detector is suitable for intermittent or continuous operation in conjunction with Kromschöder burner control units BCU 370..U, BCU 4xx..U, PFU 7xx..U or BCU 5xx..U0.

This function is only guaranteed when used within the specified limits – see also page 9 (10

Technical data). Any other use is considered as non-compliant.

2.1 Type code

UVC	UV flame detectors
1	Series 1
D	Quartz glass heat guard
L	Quartz glass heat guard lens
0	Rp 1/2 internal thread
1	Rp 1/2 internal thread and cooling air connection
G1	M20 cable gland
A	Mains voltage: 100–230 V AC, 50/60 Hz

2.2 Part designations

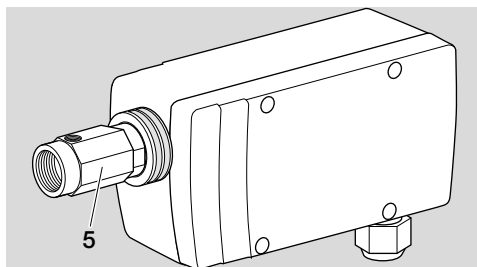
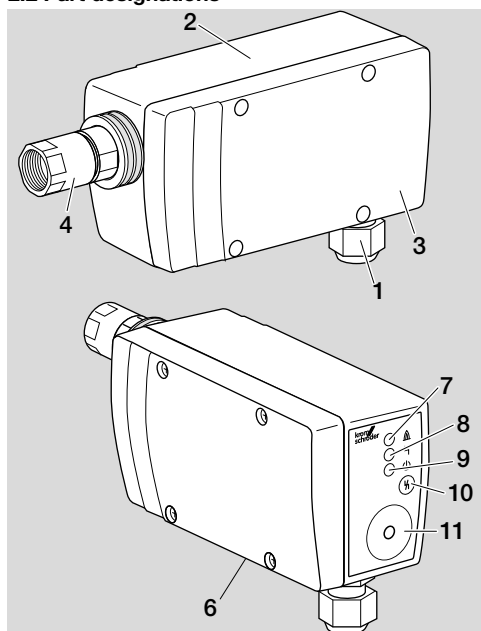

- 1 M20 cable gland
- 2 Housing
- 3 Cover
- 4 Adapter with internal thread
- 5 Adapter with internal thread and cooling air connection
- 6 Type label
- 7 Yellow LED (flame signal)
- 8 Red LED (fault)
- 9 Green LED (ready for operation)
- 10 Reset button
- 11 Connection for opto-adaptor PCO 200

2.3 Type label

Identification number (**A**), construction stage (**B**), year/week of manufacture (**C**), device number (**D**), firmware (**E**), input voltage, enclosure – see type label.

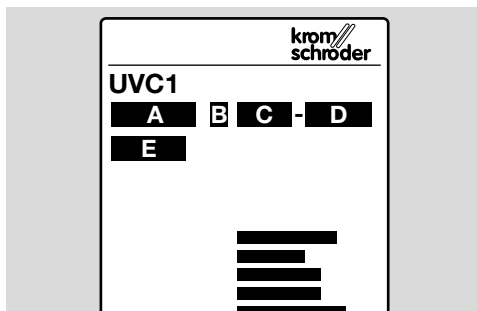

3 INSTALLATION

⚠ CAUTION

Please observe the following to ensure that the UVC 1 is not damaged:

- Only use the UV flame detector in conjunction with Kromschöder burner control units BCU 370..U, BCU 4xx..U, PFU 7xx..U or BCU 5xx..U0.
- Use the UV flame detector with cooling air connection (UVC 1..1 or UVC 1..3) in high temperatures. Cool with filtered air using the cooling air connection to provide protection from dirt and condensation.
- The installation surface temperature for the UVC 1 may be max. 20°C above the maximum ambient temperature.

- Dropping the device can cause permanent damage. In this event, replace the entire device and associated modules before use.

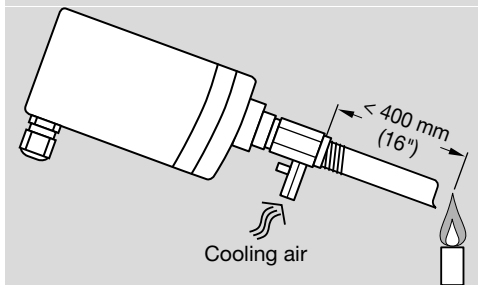

- Max. distance between UVC and flame $< 400 \text{ mm}$ ($16''$).
- It is installed using a $\frac{1}{2}$ " steel viewing tube. Direct the viewing tube at the first third of the flame as this is where the highest UV radiation is generally found. The inside of the viewing tube should not be coated and the tube should be directed at the flame from above so that no dirt collects in front of the UV flame detector.
- The UVC 1 may only be exposed to the UV light of its own flame. It should be protected from other sources of ultraviolet light, e.g. neighbouring flames (this must be observed when monitoring pilot and main burners in particular), ignition sparks, arcs from welding devices or lamps emitting ultraviolet light.
- Avoid exposing the UVC 1 viewing openings to direct sunlight.
- Protect the viewing openings against dirt and moisture.

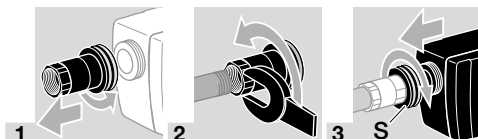

- Tighten the knurled union nut (S).

4 WIRING

⚠ WARNING

Electric shocks can be fatal!
Before working on possible live components, ensure the unit is disconnected from the power supply.

- Connection cable:
 - Use 5-core cable including a PE wire and complying with local regulations.
 - Lay individually and, if possible, not in a metal conduit.
 - Do not lay together with ignition cable but lay them as far apart as possible.
 - M20 cable gland is designed for cable diameters of 7 to 13 mm.

- Screw terminals for wire cross-sections $> 0.5 \text{ mm}^2$ to $\leq 1.5 \text{ mm}^2$ (AWG 26 to AWG 16).
- Max. cable length as specified for burner control units BCU or PFU.
- External electrical interference must be avoided.
- Ensure that a clean sinusoidal voltage is applied to the UVC 1 in order to avoid mains voltage errors due to mains voltage irregularities.

- 1 Disconnect the system from the electrical power supply.
- 2 Shut off the gas supply.
- 3 Remove the cover from the housing.
- 4 Open the cover on the connection terminals.

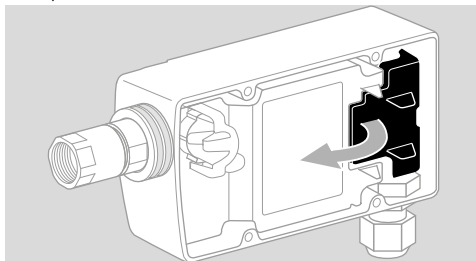

- 5 Route the cable through the M20 cable gland.
- 6 Wire the UVC 1 as shown in the connection diagram for the burner control unit, including PE wire, see page 4 (4.1 Burner control unit connection diagrams):

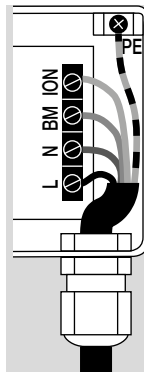

Terminal	No.	Designation
PE		PE wire
ION	4	Ionization signal
BM	3	Burner ground
N	2	Neutral conductor
L	1	Phase

4.1 Burner control unit connection diagrams

BCU 370..U

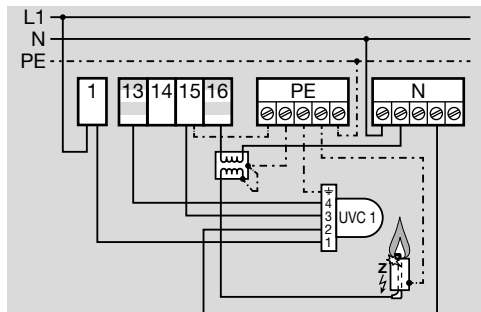

BCU 460..U

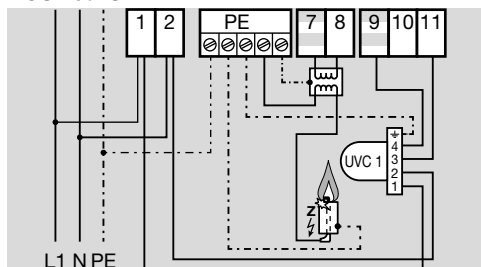

BCU 480..U

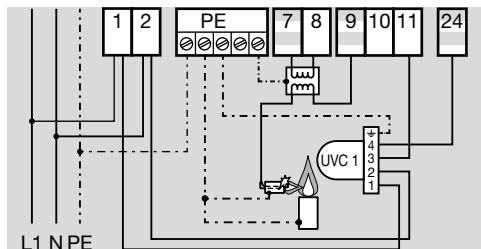

BCU 560..U0

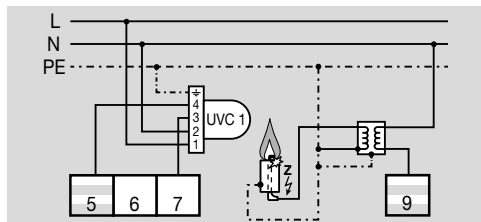

BCU 370..U

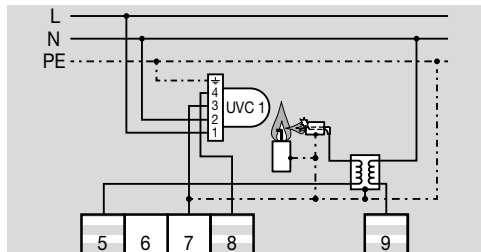

BCU 570..U0

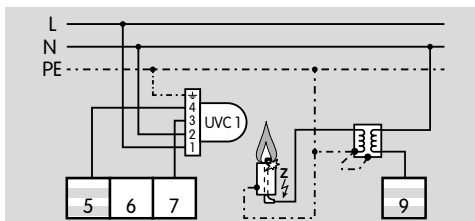

PFU 760..U

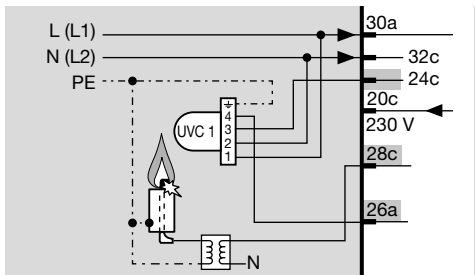

PFU 780..U

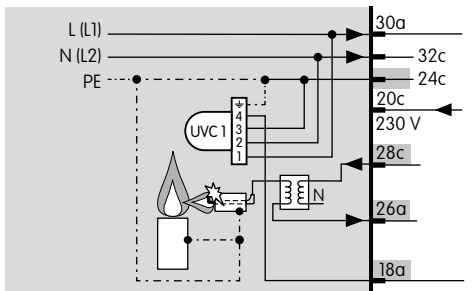

5 ADJUSTMENT

If faults occur during operation, it may be necessary to change the parameter for the switch-off threshold (parameter 01) on the UVC 1. The parameter can be set using the separate BCSofT software and the opto-adaptor PCO 200.

- The switch-off threshold can be set from 20% to 80% (in steps of 10%).
- The switch-off threshold for the flame signal cannot be set on the burner control unit when using a UVC 1.
- The factory settings are secured with a programmable password (1234).
- If the password has been changed, the end customer can look up the changed password in the plant documentation or ask the system supplier.

6 COMMISSIONING

⚠ WARNING

Only use the UV flame detector UVC 1 in conjunction with burner control units BCU 370..U, BCU 4xx..U, PFU 7xx..U or BCU 5xx..U0. For BCU 5xx, set parameter 04 to flame control with a UV sensor for continuous operation. Otherwise, the safety time may be evaluated incorrectly.

- The three LEDs (yellow, red and green) will be lit during initialization of the UVC 1.
- The green LED will be lit. The UVC 1 is ready for operation.
- The yellow LED will also be lit as soon as a flame is detected (with a maximum delay of 1 s).
- If the reset button is pressed, the yellow LED will flash to indicate the switch-off threshold, see page 8 (9 Reading or setting flame signal, parameters, statistics).
- As soon as the red LED or the red and green LEDs are lit, a fault has been detected.

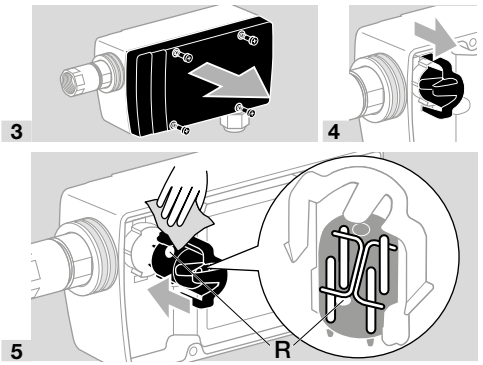

⚠ CAUTION

- To ensure that the UVC operates perfectly:
- Maintain the factory alignment of the UV tube in the bracket (**R** = red dot).
 - Do not touch the UV tube with your bare fingers.

7 MAINTENANCE

⚠ WARNING

Electric shocks can be fatal!
Before working on possible live components, ensure the unit is disconnected from the power supply.

- Check the UVC 1 at least once per year to ensure that it is securely attached and that the quartz glass disc/lens is clean.
- The tube in the UV flame detector must be replaced after approx. 10,000 operating hours (approx. 1 year).
- Spare parts (tube, seal), see www.partdetective.de.

7.1 Cleaning or replacing the quartz glass disc/lens

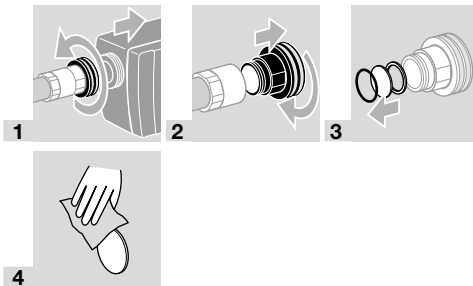

7.2 Replacing the UV tube

- 1 Disconnect the system from the electrical power supply.
- 2 Shut off the gas supply.

8 ASSISTANCE IN THE EVENT OF MALFUNCTION

⚠ WARNING

Electric shocks can be fatal!

- Before working on possible live components, ensure the unit is disconnected from the power supply.
- Fault-clearance must only be undertaken by authorized trained personell
- Do not carry out repairs on the UV flame detector on your own as this will cancel our guarantee. Unauthorized repairs or incorrect electrical connections can cause the UV flame detector to become defective.
- Resets may only be conducted by authorized trained personnel with continuous monitoring of the burner to be reset.
- Safe operation only in conjunction with Kromschroder burner control units.

Safety shut-down

- The red and green LEDs will be lit.
 - Reset the UVC by pressing the reset button after the fault has been rectified.

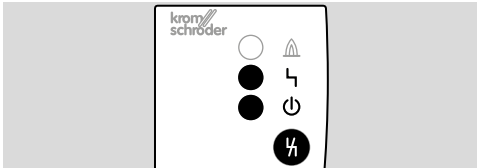

Fault lock-out/Device error

- Only the red LED will be lit.
 - Reset the UVC by pressing and holding the reset button (> 5 s).

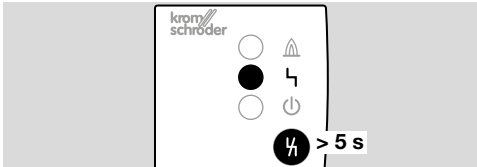

? Fault

- ! Cause
 - Remedy
- If the UVC does not respond even though all faults have been remedied: remove the unit and return it to the manufacturer for inspection.

? The yellow LED “Flame signal” is lit although there is no flame.

- ! The UV flame detector is influenced by the flames of other burners, e.g. by reflection on the furnace walls.
 - Position the UV flame detector so that it can only “see” its own dedicated flame (e.g. use viewing tube).
- ! Sensitivity of the UV flame detector is too high.

- Increase the switch-off threshold using BCSoft.

- ! The UV tube is defective.
 - Replace the UV tube, see page 5 (7 Maintenance).
- ? **The yellow LED “Flame signal” is not lit although there is a flame.**
 - ! The UV flame detector is dirty, e.g. sooted.
 - Clean the quartz glass disc/lens.
 - ! There is moisture in the burner adapter.
 - Vent the burner adapter.
 - ! The UV flame detector is too far away from the flame.
 - Reduce the distance.
 - ! No UV tube has been inserted.
 - Insert a UV tube.
 - ! After many hours of operation, the flame signal becomes weaker, the UV tube ages.
 - Replace the UV tube, see page 5 (7 Maintenance).
- ? **The yellow LED “Flame signal” is lit, but the burner control unit does not detect a flame signal.**
 - Measure the flame signal.
- If the current is less than 5 µA, this may be attributable to the following causes:
 - ! Short-circuit or discontinuity on the flame signal cable.
 - ! UV flame detector or burner control unit is not correctly wired.
 - ! The flame signal cable is too long.
 - ! Sources of interference, e.g. ignition transformers, are influencing the flame signal.
 - Remedy fault.
- ? **The red LED “Fault” is lit.**
 - ! The UV tube is defective.
 - Replace the UV tube, see page 5 (7 Maintenance).
 - ! The unit is defective.
 - Remove the unit and return it to the manufacturer for inspection.
- ? **The red LED “Fault” flashes.**
 - ! The printed circuit board temperature is above 95°C, see page 9 (10 Technical data).
- The function of the UV flame detector is not restricted.
- The service life of the UV tube may be reduced as a result.
 - Provide a cooler ambient temperature.
- As soon as the UVC is in the normal operating temperature range, the red LED stops flashing.
- ? **The green LED “Ready for operation” is not lit.**
 - ! Incorrect wiring.

- Check the wiring, see page 4 (4.1 Burner control unit connection diagrams).

! Fuse defective.

- Send back the unit.

! UVC 1 has suffered a device error.

- Read the error with BCSoft and react accordingly.

! UVC 1 has carried out a fault lock-out.

- Read the error with BCSoft and react accordingly.

? The burner ignites in pulses.

! The UV flame detector “sees” the ignition spark.

- Reposition the UV flame detector so that it cannot “see” the ignition spark.
- Use a burner control unit that is able to distinguish between an ignition spark and a flame signal.

? The burner control unit performs a fault lock-out during start-up with the fault message “No flame” or during operation indicating “Flame failure”.

! The highly fluctuating flame signal temporarily falls below the switch-off threshold.

- Reduce the distance between UV flame detector and flame.
- Position the UV flame detector so that it can “see” the flame without hindrance (e.g. smoke curtain).

! The switch-off threshold is set too high.

- Reduce the switch-off threshold using BCSoft.

Reading fault messages using BCSoft

→ Fault messages can be read from the UVC 1 using the opto-adapter PCO 200, which is an additional extra, and the BCSoft program, see page 10 (13 Accessories) and the BCSoft operating instructions at www.docuthek.com.

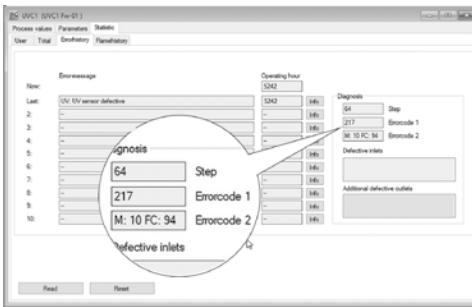

? The BCSoft error history on the Statistics tab displays Errorcode 1 = 30 or 31.

! Abnormal data change in the value range set for the adjustable UVC 1 parameter.

- Reset the parameter to its original value using the BCSoft software.
- Establish the cause of the fault to avoid repeat faults.
- Ensure that the cables have been installed properly – see page 3 (4 Wiring).
- If the measures described above do not help, remove the unit and return it to the manufacturer for inspection.



? The BCSoft error history on the Statistics tab displays Errorcode 1 = 32.

! Supply voltage too low or too high.

- Operate the BCU in the specified mains voltage range (mains voltage +10/-15%, 50/60 Hz).

! An internal device error occurred.

- Remove the unit and return it to the manufacturer for inspection.



? The BCSoft error history on the Statistics tab displays Errorcode 1 = 33.

! Faulty parameterization.

- Check parameter settings using BCSoft and adjust them if necessary.

! An internal device error occurred.

- Remove the unit and return it to the manufacturer for inspection.

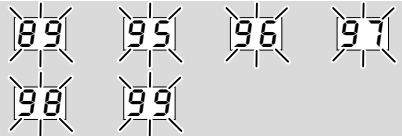

? The BCSoft error history on the Statistics tab displays Errorcode 1 = 89, 95, 96, 97, 98 or 99.

! System fault – the UVC 1 has performed a safety shut-down. The cause may be a unit defect or abnormal EMC influence.

- Ensure that the ignition cable has been installed correctly.
- Ensure that the EMC regulations for the system are satisfied – particularly for systems with frequency converters.
- Reset the unit.



- Disconnect the UVC 1 from the mains supply and then switch it on again after approx. 10 s.
- Check mains voltage and frequency.
- If the measures described above do not help, the unit has probably suffered a hardware defect – remove the unit and return it to the manufacturer for inspection.



? The BCSoft error history on the Statistics tab displays Errorcode 1 = 94.

! Internal error due to UV pulse. A flame is detected when the shutter is closed. The mechanical shutter is displaced or blocked.

- Check the shutter.

! The UV tube simulates an incorrect flame signal.

- Replace the UV tube.



? The BCSoft error history on the Statistics tab displays Errorcode 1 = 217.

! UV tube dark test error. A flame is detected when the shutter is closed. The mechanical shutter is displaced or blocked.

- Check the shutter.

! The UV tube simulates an incorrect flame signal.

- Replace the UV tube.

9 READING OR SETTING FLAME SIGNAL, PARAMETERS, STATISTICS

Reading from the UVC

Flame signal:

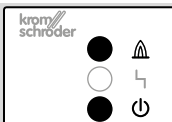

→ The yellow and green LEDs are lit during operation: the flame signal is above the switch-off threshold.

Parameterization:

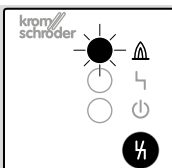

1 Press the reset button during operation.

→ The yellow LED flashes x times (e.g. flashes 3 times: the switch-off threshold is 30%).

Reading/Setting using BCSoft

Using an optionally available opto-adaptor PCO, it is possible to set parameter 01 and read analysis and diagnostic information from the UVC using the BCSoft program, see BCSoft operating instructions V 4.0.0 at www.docu.thek.com.

→ The switch-off threshold can be set from 20 to 80% (in steps of 10%).

10 TECHNICAL DATA

Ambient conditions

Condensation and dew in and on the unit are not permitted.

Avoid direct sunlight or radiation from red-hot surfaces on the unit.

Avoid corrosive influences, e.g. salty ambient air or SO₂.

Permitted relative humidity: min. 5%, max. 95%.

This unit is not suitable for cleaning with a high-pressure cleaner and/or cleaning products.

The unit may only be stored/installed in enclosed rooms/buildings.

Ambient temperature: -20 to +80°C (-4 to +176°F), no condensation/icing permitted.

Transport temperature = ambient temperature.

Storage temperature: -20 to +60°C (-4 to +140°F).

Enclosure: IP 65.

Safety class: 1.

Pollution degree: internal environment: 2, external environment: 4.

Permitted operating altitude: < 2000 m AMSL.

Mechanical data

Housing: aluminium.

Cable gland for cable diameters of 7 to 13 mm.

Clamping range of the connection terminals:

0.5 to 1.5 mm² (AWG 26 to AWG 16).

Weight: 1 kg.

Electrical data

Supply voltage:

100 to 230 V AC, -15/+10%, 50/60 Hz (terminals L and N).

Length of cable between UV flame detector and automatic burner control unit: min. 2 m, max. 100 m (note the specifications for the connected burner control unit).

Distance between UV flame detector and flame: 300 to 400 mm.

UV tube: R16388,

spectral range: 185 to 280 nm,

max. sensitivity: 210 nm ± 10 nm.

Min. DC signal: 1 µA.

11 DESIGNED LIFETIME

This information on the designed lifetime is based on using the product in accordance with these operating instructions. Once the designed lifetime has been reached, safety-relevant products must be replaced.

Designed lifetime (based on date of manufacture) for UVC 1: 10 years.

Designed lifetime of the UV tube:

approx. 10,000 operating hours (approx. 1 year).

You can find further explanations in the applicable rules and regulations and on the afecor website (www.afecor.org).

This procedure applies to heating systems. For thermoprocessing equipment, observe local regulations.

12 SAFETY INSTRUCTIONS

Scope of application:

as set out in "Industrial thermoprocessing equipment – Part 2: Safety requirements for combustion and fuel handling systems" (EN 746-2) when used with fuels and oxidants which emit UV radiation during oxidation.

Action:

Type 2 pursuant to EN 60730-1.

Behaviour under fault conditions:

Pursuant to Type 2.AD2.Y. During a fault, the UVC 1 switches off and uses a trip-free mechanism which cannot be reclosed.

Fault detection time:

≤ 10 min during operation depending on the number of testing cycles for the UV tube by the integrated shutter.

Safety time during operation (in the event of a flame failure):

< 0.5 s.

Intermittent operation:

Possible pursuant to EN 298, Section 7.101.2.9. As a result of the fault detection time, depending on the process time it may happen that a defective tube is not detected during the self-check using the shutter. A flame simulation check must be conducted before starting the burner control unit.

Software class: corresponds to software class C which operates in a similar double-channel architecture with comparison.

Short-circuit fault exclusion:

No. Internal voltages are neither SELV nor PELV.

Interfaces

Type of wiring:

Attachment type X to EN 60730-1.

Connection terminals:

Supply voltage: 100 to 230 V AC, 50/60 Hz, between terminals L and N.

Ionization signal: 230 V AC between terminals ION (ionization output) and BM (burner ground). The voltage is provided by the burner control unit/automatic burner control unit.

DC signal:

No flame: < 1 µA.

Active flame: 5 to 25 µA, depending on flame quality.

Grounding:

Using PE wire connection, galvanically connected to the housing.

13 ACCESSORIES

13.1 Nozzle for cooling air adapter

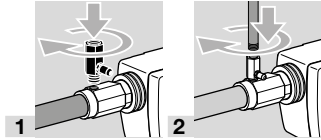
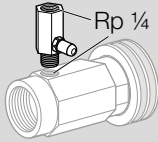

Rp 1/4, d = 2.3 mm, Order No.: 74960637

Rp 1/4, d = 3.3 mm, Order No.: 74960638

Rp 1/4, d = 4.5 mm, Order No.: 74960616

13.2 Quartz glass disc/lens

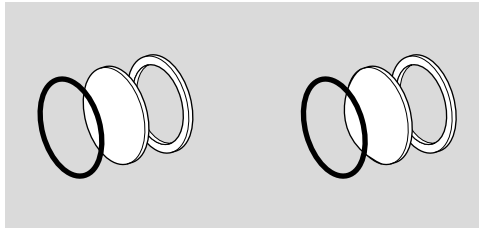

Quartz glass disc with seal,
Order No.: 74960612.

Quartz glass lens with seal,
Order No.: 74960611;

when installing, ensure that the lens curvature points towards the flame. Precisely align the UV sensor.

The gap between the UV sensor and the flame can be increased to approximately 600 to 1200 mm (23" to 47").

13.3 Adapter with quartz glass lens

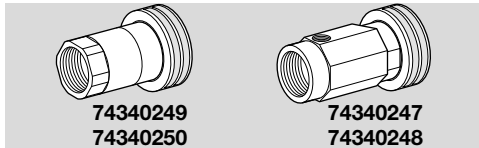

For focusing weak UV radiation in order to generate a stronger UV signal. Use this to replace the existing adapter.

Type	Adapter	Order No.
UVC1D0G1A	Adapter Rp 1/2	74340249
UVC1D1G1A	Cooling air adapter Rp 1/2	74340247
UVC1D2G1A	1/2" NPT adapter	74340248
UVC1D3G1A	1/2" NPT cooling air adapter	74340250

13.4 BCSoft

The current software can be downloaded from our Internet site at www.docuthek.com. To do so, you need to register in the DOCUTHEK.

13.5 Opto-adapter PCO 200

Including BCSoft CD-ROM,
Order No.: 74960625.

13.6 Spare UV tube

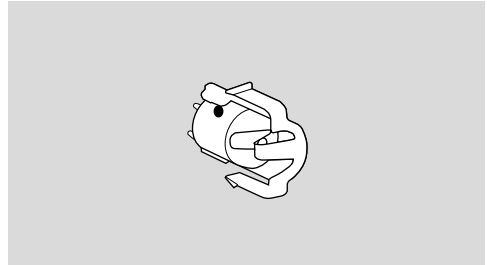

With bracket,
Order No.: 74960684.

14 LOGISTICS

Transport

Protect the unit from external forces (blows, shocks, vibration).

Transport temperature: see page 9 (10 Technical data).

Transport is subject to the ambient conditions described.

Report any transport damage on the unit or packaging without delay.

Check that the delivery is complete.

Storage

Storage temperature: see page 9 (10 Technical data).

Storage is subject to the ambient conditions described.

Storage time: 6 months in the original packaging before using for the first time. If stored for longer than this, the overall service life will be reduced by the corresponding amount of extra storage time.

15 CERTIFICATION

Certificates – see www.docuthek.com

15.1 Declaration of conformity



We, the manufacturer, hereby declare that the product UVC 1 complies with the requirements of the listed Directives and Standards.

Directives:

- 2014/30/EU
- 2014/35/EU

Regulation:

- (EU) 2016/426 – GAR

The relevant product corresponds to the tested type sample.

The production is subject to the surveillance procedure pursuant to Regulation (EU) 2016/426 Annex III paragraph 3.

Elster GmbH

15.2 SIL and PL



For systems up to SIL 3 pursuant to IEC 61508. Pursuant to EN ISO 13849-1:2006, Table 4, the UVC 1 can be used up to PL e.

Safety-specific characteristic values

Diagnostic coverage DC	94.7%
Type of subsystem	Type B to EN 61508-2
Mode of operation	High demand mode pursuant to EN 61508-4, continuous operation (to EN 298)
Mean probability of dangerous failure PFH _D	10.2×10^{-9} 1/h
Mean time to dangerous failure MTTF _d	1/PFH _D
Safe failure fraction SFF	98.9%

15.3 FM approved



Factory Mutual (FM) Research Class: 7610 “Combustion Safeguards and Flame Sensing Systems”. www.approvalguide.com

15.4 UL listed



Underwriters Laboratories UL 60730 – Automatic Electrical Controls

15.5 AGA approved



Australian Gas Association, Approval No.: 8586 www.aga.asn.au

15.6 UKCA certified



Gas Appliances (Product Safety and Metrology etc. (Amendment etc.) (EU Exit) Regulations 2019) BS EN 298:2012

15.7 Eurasian Customs Union



The products UVC 1 meet the technical specifications of the Eurasian Customs Union.

15.8 REACH Regulation

The device contains substances of very high concern which are listed in the Candidate List of the European REACH Regulation No. 1907/2006. See Reach list HTS at www.docuthek.com.

15.9 China RoHS

Directive on the restriction of the use of hazardous substances (RoHS) in China. Scan of the Disclosure Table China RoHS2, see certificates at www.docuthek.com.

16 DISPOSAL

Devices with electronic components:

WEEE Directive 2012/19/EU – Waste Electrical and Electronic Equipment Directive



At the end of the product life (number of operating cycles reached), dispose of the packaging and product in a corresponding recycling centre. Do not dispose of the unit with the usual domestic refuse. Do not burn the product.

On request, old units may be returned carriage paid to the manufacturer in accordance with the relevant waste legislation requirements.

FOR MORE INFORMATION

The Honeywell Thermal Solutions family of products includes Honeywell Combustion Safety, Eclipse, Exothermics, Hauck, Kromschroder and Maxon. To learn more about our products, visit ThermalSolutions.honeywell.com or contact your Honeywell Sales Engineer.

Elster GmbH
Strotheweg 1, D-49504 Lotte
T +49 541 1214-0
hts.lotte@honeywell.com
www.kromschroeder.com

Global centralized service deployment coordination:
T +49 541 1214-365 or -555
hts.service.germany@honeywell.com

Translation from the German
© 2024 Elster GmbH

Honeywell
krom
schröder